

Varenummer: 2314451701
 Beskrivelse: E+G Aluminiums hjul 451701
 RE.F5-125-SSL-H Drejeligt konsol u/bremse

Mål

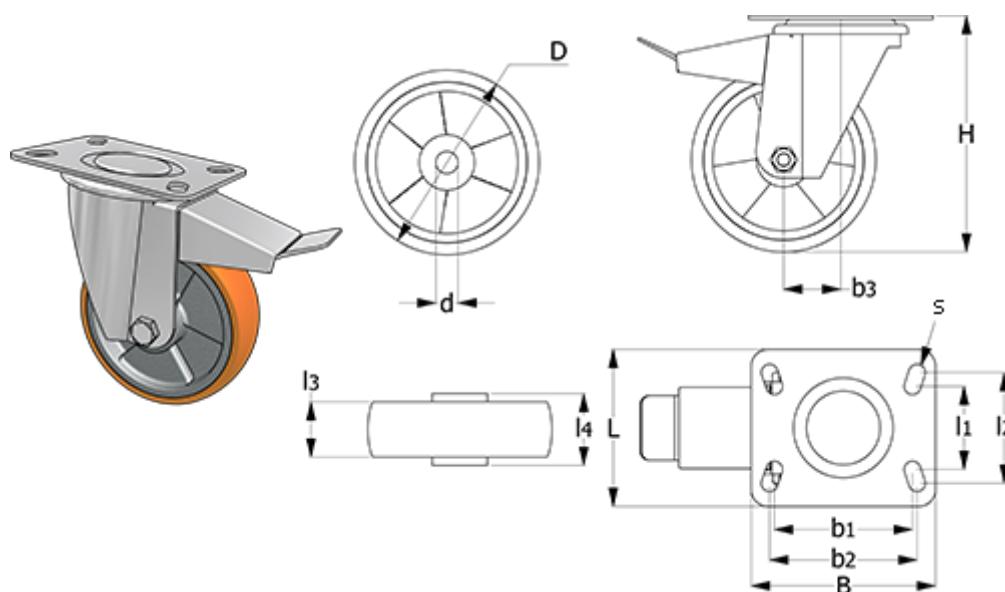

B	= 100	Kode	= 451701	Type	= RE.F5-125-SSL-H
b1	= 75	L	= 85	Vægt (g)	= 1390
b2	= 80	l1	= 45		
b3	= 48	l2	= 60		
D	= 125	l3	= 35		
d	= 12	l4	= 40		
Dynamisk belastning (N)	= 3500	Rullemodstand (N)	= 2800		
H	= 161	s	= 9		